

**MITEL**

# 5207 | IP Phone

USER GUIDE

 **MITEL** | it's about **YOU**





# Contents

<b>ABOUT YOUR PHONE</b>	1
For Users on Resilient 3300 ICP Systems	3
<b>TIPS FOR YOUR COMFORT AND SAFETY</b>	3
Don't cradle the handset!	3
Protect your hearing	4
Angle the phone for easier viewing	4
<b>CUSTOMIZING YOUR PHONE</b>	5
Ringer Control	5
Handset Receiver Volume Control	5
Speaker Volume Control	5
Display Contrast Control	5
Feature Keys	6
Language Change	6
<b>MAKING AND ANSWERING CALLS</b>	6
Make a call	6
Answer a call	6
Redial	7
Redial - Saved Number	7
Speed Call Keys	8
Speed Call - Personal	9
On-Hook Dialing	9
Auto-Answer	9

<b>CALL HANDLING</b>	10
Hold	10
Transfer	10
Conference	11
Conference Split	11
Swap	11
Call Forward	12
Call Forward - Remote	13
Call Forward - End Chaining	13
Call Forward - Override	14
Messaging - Advisory	14
Messaging - Callback	14
Messaging - Cancel Callback	15
Messaging - Cancel All Callbacks	15
<b>USING ADVANCED FEATURES</b>	15
Account Codes	15
Call Park	16
Call Pickup	16
Camp-on	16
Do Not Disturb	17
Override	17
Paging	17
Direct Paging	18
Handsfree Operation	19
Headset Operation	20
Headset Operation (with Feature Control Switch)	21
Music	21
Group Paging / Meet Me Answer	22
Trunk Flash	22
Record a Call	23
Hot Desking	24
Tag Call	25
Call History	26
<b>FEATURE ACCESS CODES</b>	28

## ABOUT YOUR PHONE

The Mitel 5207 IP phone has ten fixed-function keys ( **SUPERKEY**, **MESSAGE**, **HOLD**, **CANCEL**, **TRANS/CONF**, **REDIAL**, **SPEAKER**, **MICROPHONE**, ,  ) and 14 personal keys with built-in status indicators. The personal key on the bottom right is always your Prime Line; the remaining personal keys can be programmed as:

- Feature keys (for example, Swap). You can program feature keys using the Desktop Tool. Your administrator can also program feature keys.
- Speed Call keys. You can program speed call keys from your phone, or using the Desktop Tool.
- Line Appearances. Only the administrator can program line appearances.

**Note:** For more information on the Desktop Tool, talk to your system administrator.

Your telephone also features display-assisted selection of features, on-hook dialing, and a large Message Indicator.

**Note:** When using the **SuperKey**, press **Cancel** or **SuperKey** to back up one menu level.

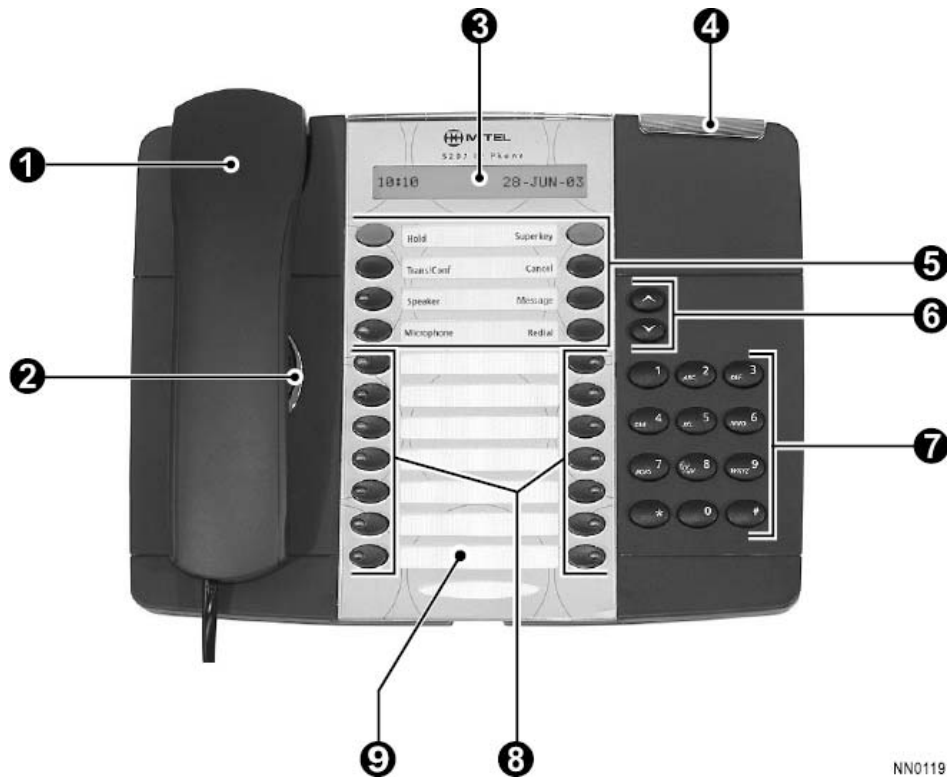

NN0119

1. Handset
2. Speaker
3. Display
4. Message Waiting Indicator
5. Fixed-Function Keys
6. Volume Control
7. Keypad
8. Programmable Feature Keys
9. Designation Card

## **IMPORTANT NOTE FOR HEADSET USERS:**

Mitel Headsets with Feature Control Switch must be installed in the dedicated headset jack (the jack nearest the front of the set). Installation will disable your handset microphone. Disconnecting the headset at the jack or at the quick-disconnect plug restores handset operation.

### *Telephone status indicators*

<b>When line is</b>	<b>the indicator is</b>
Idle	Off
Busy	On
Ringing	Flashing slowly
On hold at your set	Flashing rapidly
On hold at another set	Flashing slow on/fast off

## **For Users on Resilient 3300 ICP Systems**

If during a call, you hear two beeps repeated every 20 seconds it means that your phone is switching to a secondary 3300 ICP system. The call continues and there is a change in the operation of some keys and features on your phone. Normal operation resumes when your phone switches back to the primary system. If your phone is idle and switched to the secondary system, you'll see a flashing rectangle on the display. The rectangle remains until the switch to the primary system is complete.

## **TIPS FOR YOUR COMFORT AND SAFETY**

### **Don't cradle the handset!**

Prolonged use of the handset can lead to neck, shoulder, or back discomfort, especially if you cradle the handset between your ear and shoulder. If you use your phone a lot, you may find it more comfortable to use a headset. See the section on headset usage elsewhere in this guide for more information.

## Protect your hearing

Your phone has a control for adjusting the volume of the handset receiver or headset. Because continuous exposure to loud sounds can contribute to hearing loss, keep the volume at a moderate level.

## Angle the phone for easier viewing

The stand built into your phone tilts to give you a better view of the keys.

*To tilt your telephone for better viewing:*

1. Press the release tabs on these sides of the stand.
2. Hinge the two front hooks and snap the two back hooks of the stand into either the upper or lower notches on the back of the phone.

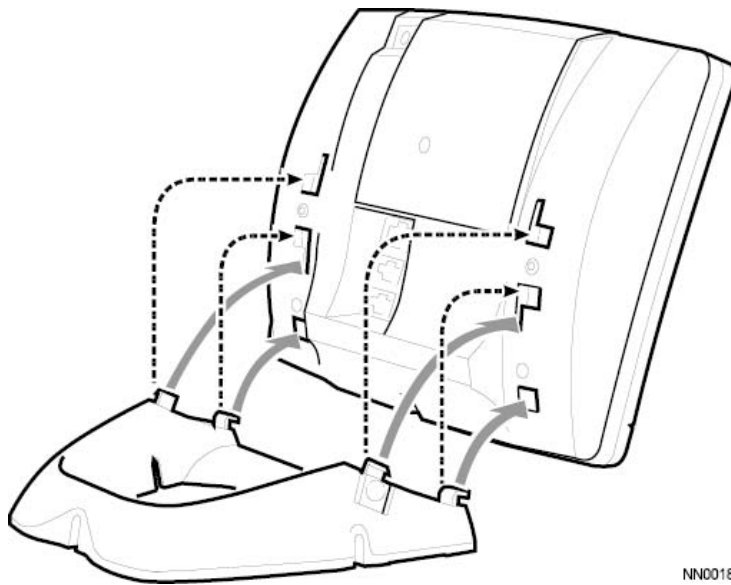

NN0018





# CUSTOMIZING YOUR PHONE

## Ringer Control

*To adjust the Ringer Volume while the set is ringing:*

- Press , .

*To adjust the Ringer Pitch while the set is idle:*

1. Press **SUPERKEY**.
2. Press # until "Ringer Adjust?" appears.
3. Press \*. "Adjust Pitch?" appears.
4. Press \* for Yes.
5. Press ,  to adjust pitch.
6. Press # to save pitch level. "Adjust Volume?" appears.
7. Press \* for Yes.
8. Press ,  to adjust volume level.
9. Press # to save volume level.
0. Press **SUPERKEY**.

## Handset Receiver Volume Control

*To adjust the Handset Receiver Volume when you are using the handset:*

- Press , .

## Speaker Volume Control

*To adjust the Speaker Volume when making an on-hook call or when listening to background music:*

- Press , .

## Display Contrast Control

*To adjust the Display Contrast while your set is idle:*

- Press , .

## Feature Keys

*To display information about a key:*

1. Press **SUPERKEY**.
2. Press a personal key.
3. Press **SUPERKEY**.

## Language Change

*To change the display language:*

1. Press **SUPERKEY**.
2. Press # until "Language?" appears.
3. Press \* for Yes.
4. Press \* to change language.
5. Press # until the desired language appears.
6. Press \* to save your selection.

# MAKING AND ANSWERING CALLS

## Make a call

1. Lift the handset.
2. If you want to use a Non-Prime Line, press a Line Appearance key.
3. Dial the number,  
-OR-  
Press a Speed Call key  
-OR-  
Press **REDIAL**.

## Answer a call

- Lift the handset.  
-OR-  
Press the flashing Line appearance key and lift the handset.

## **Redial**

*To redial the last number that you manually dialed:*

1. Lift the handset.
2. Press **REDIAL**.

## **Redial - Saved Number**

*To save the last number that you manually dialed:*

1. Lift the handset.
2. Dial **\*\*79**.

*To Redial a saved number:*

1. Lift the handset.
2. Dial **\*6\***.

## Speed Call Keys

You may use Speed Call Keys to make a call or to send a string of digits during a call (press a Speed Call Key during a call to send a multi-digit password, for instance).

*To dial a stored Speed Call number:*

1. Lift the handset.
2. Press a Speed Call key.

*To store a Speed Call number:*

1. Press **SUPERKEY**.
2. Press **#** until "Personal Keys?" appears.
3. Press **\*** for Yes.
4. Press a personal key that isn't a line key.
5. Press **\*** for Change.
6. Do one of the following:
  - To store a new number, dial the number (press **HOLD** between digits to create a one-second pause during dialing; press **HOLD** more than once to lengthen the pause).
  - To enter a trunk flash, press **TRANS/CONF**. (See "Trunk Flash" for more information about the use of this feature.)
  - To enter the last number dialed, press **REDIAL**.
7. Press the personal key again to save the number.
8. Do one of the following:
  - To make the number private, press **\***.
  - To keep the number visible, press **#**.
9. Press **SUPERKEY**.

## Speed Call - Personal

*To dial a stored personal Speed Call number:*

1. Lift the handset.
2. Dial **58**.
3. Enter an index number between **00** and **09**.

*To store a personal Speed Call number:*

1. Lift the handset.
2. Dial **67**.
3. Enter an index number between **00** and **09**.
4. Dial the number to be stored (press **Hold** between digits to create a one-second pause during dialing; press **Hold** more than once to lengthen the pause).
5. Hang up.

## On-Hook Dialing

*To dial without lifting the handset:*

1. If you want to use a Non-Prime Line, press a Line Appearance key.
2. Dial the number.
3. Lift the handset.

## Auto-Answer

*To enable or disable Auto-Answer:*

- Press the **Auto-Answer** feature key.

*To answer a call when you hear ringback:*

- Communicate using the speaker and microphone.

# CALL HANDLING

## Hold

*To place a call on Hold:*

- Press **Hold**.

*To retrieve a call from Hold:*

1. Lift the handset.
2. Press the flashing line key.

*To retrieve a call from Hold at another station:*

- Press the flashing line key.  
-OR-  
Dial **\*\*1** and the number of the station that placed the call on Hold.

## Transfer

*To Transfer an active call:*

1. Press **TRANS/CONF**.
2. Dial the number of the third party.
3. Do one of the following:
  - To complete the Transfer, hang up.
  - To announce the Transfer, wait for an answer, consult, and hang up.
  - To cancel the Transfer, press **CANCEL**.

*To transfer an active call during headset operation:*

1. Press **TRANS/CONF**.
2. Dial the number of the third party.
3. To complete the Transfer, press the **Release** feature key.

## Conference

*To form a Conference when a two-party call is already in place, or to add another party to an existing Conference:*

1. Press **TRANS/CONF**.
2. Dial the number of the next party.
3. Wait for an answer.
4. Press **TRANS/CONF**.

*To leave a Conference:*

- Hang up.

## Conference Split

*To Split a Conference and speak privately with the original party:*

1. Press **TRANS/CONF**.
2. Dial **\*41**.

## Swap

*To call another party when you are in an established two-party call:*

1. Press **TRANS/CONF**.
2. Dial the number.

*To alternate between the two parties:*

- Press the **Swap/Trade** feature key.

## Call Forward

Call Forward lets you redirect incoming calls to an alternate number. ALWAYS redirects all incoming calls regardless of the state of your telephone. B-INT redirects internal calls when your telephone is busy, and B-EXT redirects external calls when your telephone is busy. NA-INT redirects internal calls after several rings if you don't answer, and NA-EXT redirects external calls after several rings if you don't answer.

**Note:** For information about "I AM HERE", see Call Forward - Remote.

*To program Call Forward:*

1. Press **SUPERKEY**.
2. Press # until "Call Forwarding?" appears.
3. Press \* for Yes.
4. Press # until the type of Call Forward that you want to set up appears (see above).
5. Press \* for Review.
6. If a number is already programmed, press \* for change.
7. Press \* to Program.
8. Dial the destination number.
9. Press  to Save.
10. Continue programming other types of Call Forward, or press **SUPERKEY** to leave programming mode.

*To turn Call Forward on and off (once it has been programmed):*

1. Press **SUPERKEY**.
2. Press # until "Call Forwarding?" appears.
3. Press \* for Yes.
4. Do one of the following:
  - To turn Call Forward ALWAYS on or off, press \* for Review, press \* for Change and then press # to turn on or off.
  - To turn another type of Call Forward on or off, press # until you reach the desired display. Press \* for Review, press \* for Change and then press # to turn on or off.
5. Continue turning other types of Call Forward on or off, or press **SUPERKEY** to leave programming mode.

## Call Forward - Remote

*To forward calls from a remote station to your current location:*

1. Press **SUPERKEY**.
2. Press **#** until "Call Forwarding?" appears.
3. Press **\*** for Yes.
4. Press **#** until "I AM HERE?" appears.
5. Press **\*** for Review.
6. If a number is already programmed, press **\*** for Change.
7. Press **\*** to Program.
8. Dial the extension number of the remote station.
9. Press **⏏**.
10. Press **SUPERKEY** to exit.

*To cancel Call Forward - Remote from the station that set the remote forwarding:*

1. Lift the handset.
2. Dial **\*\*77**.
3. Dial the extension of the remote station.
4. Hang up.

*To cancel Call Forward - Remote from the station that was forwarded:*

1. Lift the handset.
2. Dial **#8**.
3. Hang up.

## Call Forward - End Chaining

*To ensure that calls do not get forwarded again by the destination number:*

1. Lift the handset.
2. Dial **64**.
3. Hang up.

*To again allow calls to be forwarded by the destination number:*

1. Lift the handset.
2. Dial **\*\*73**.
3. Hang up.

## **Call Forward - Override**

*To override Call Forward and ring a station:*

1. Lift the handset.
2. Dial **\*1\***.
3. Dial the extension number.

## **Messaging - Advisory**

*To turn Messaging - Advisory on:*

1. Press **SUPERKEY**.
2. Press **\***.
3. Press **#** until the desired message appears.
4. Press **\***.

*To turn Messaging - Advisory off:*

1. Press **SUPERKEY**.
2. Press **\***.
3. Press **\***.

## **Messaging - Callback**

*To leave a Callback Message on a telephone when you hear busy or ringback tone:*

- Press **MESSAGE**.

*To respond to a message waiting condition on your telephone:*

1. Press **MESSAGE**.
2. Do one of the following:
  - To call the message sender, press **#**.
  - To erase the message, press **\***.

*To answer a Callback:*

- Lift the handset.

## **Messaging - Cancel Callback**

*To cancel a Callback:*

1. Lift the handset.
2. Dial **#1\***.
3. Dial the number of the called station.
4. Hang up.

## **Messaging - Cancel All Callbacks**

*To cancel all Callbacks:*

1. Lift the handset.
2. Dial **#1**.
3. Hang up.

# **USING ADVANCED FEATURES**

## **Account Codes**

*To use Forced Account Codes:*

1. Lift the handset.
2. Dial the Account Code digits.
3. Press **#**.

*To enter an Account Code during a call:*

1. Press **TRANS/CONF**.
2. Dial **\*\*3**.
3. Dial the Account Code digits.
4. Press **#**.
5. Press **CANCEL**.

## **Call Park**

*To retrieve a call parked by the attendant:*

1. Lift the handset.
2. Dial **\*23**.
3. Dial the console ID and the Hold Slot number.

## **Call Pickup**

*To answer a call that is ringing at another station in your Pickup Group:*

1. Lift the handset.
2. Press the **Pickup** feature key.

*To answer a call that is ringing at a station not in your Pickup Group:*

1. Lift the handset.
2. Dial **\*\*6**.
3. Dial the number of the ringing station.

## **Camp-on**

*To Camp-on to a busy station:*

- Press the **Camp-on** feature key.

*To retrieve a call when you hear Camp-on tone:*

- Press the **Swap** feature key.

## **Do Not Disturb**

*To activate or deactivate Do Not Disturb:*

- Press the **Do Not Disturb** feature key.

*To activate Do Not Disturb from a remote station:*

1. Lift handset.
2. Dial **\*\*5**.
3. Dial the number of the station to which **Do Not Disturb** is to apply.
4. Hang up.

*To deactivate Do Not Disturb from a remote station:*

1. Lift handset.
2. Dial **##5**.
3. Dial the number of the station with **Do Not Disturb** activated.
4. Hang up.

## **Override**

*To use Override when you encounter busy or DND tone:*

- Press the **Override** feature key.

## **Paging**

*To use Paging:*

1. Lift handset.
2. Press the **Pager** feature key.
3. Dial the Paging zone number (if required).
4. Make the announcement.

## **Direct Paging**

Direct Paging allows you to page a party through their telephone speaker. If the paged party has Off-Hook Voice Announce enabled, the page will be heard even when the party is on a handset or headset call.

*To page a party:*

1. Lift the handset.
2. Dial **\*37**.
3. Dial the extension number.
4. Speak to the dialed party after the tone.

*To answer a Direct Page (indicated by a single burst of tone):*

- Lift handset.

## **Handsfree Operation**

*To use Handsfree Operation to make calls:*

1. If you want to use a Non-Prime Line, press a Line Appearance key.
2. Dial the number.
3. Communicate by using the speaker and the microphone.

*To use Handsfree Operation to answer calls:*

1. Press the flashing line key.
2. Communicate by using the speaker and the microphone.

*To hang up while using Handsfree Operation:*

- Press **SPEAKER**.

*To temporarily disable the microphone during Handsfree Operation:*

- Press **MICROPHONE** (the microphone LED turns off).

*To re-enable the microphone and return to the conversation:*

- Press **MICROPHONE** (the microphone LED turns on).

*To switch from Handsfree Operation to the handset:*

- Lift the handset.

*To return to Handsfree Operation:*

1. Press **SPEAKER**.
2. Replace the handset.

## Headset Operation

*To enable Headset Operation:*

- Press the **Headset** feature key.

*To answer a call (when Auto Answer is disabled):*

- Press the flashing line key.

*To hang up:*

- Press **CANCEL**.

*To disable Headset Operation:*

- Press the **Headset** feature key.

## Headset Operation (with Feature Control Switch)

**IMPORTANT NOTE:** Mitel Networks Headsets with Feature Control Switch must be installed in the dedicated headset jack (the jack nearest the front of the set). Installation will disable your handset microphone. Disconnecting the headset at the jack or at the quick-disconnect plug restores handset operation. If handset operation is required for an extended period of time, you should press the Headset feature key to return the telephone to handset mode.

*To enable Headset Operation:*

- Press the **Headset** feature key.

*To answer a call:*

- Press flashing Line Appearance key  
-OR-  
Quickly press and release the headset's feature control switch.

*To mute the headset microphone:*

- Press and hold the headset's feature control switch.

*To hang up:*

- Press **CANCEL**.  
-OR-  
Quickly press and release the headset's feature control switch.

*To disable Headset Operation:*

- Press the **Headset** feature key.

## Music

*To turn Music on and off when the set is idle:*

- Press the **Music** feature key.

## Group Paging / Meet Me Answer

Group Paging allows you to page a group of telephones through their built-in speakers. You can belong to as many as three paging groups with one group designated as your "prime" group.

When you need to respond to a Group Page but don't know the identity or extension number of the paging party, use the Meet Me Answer feature. You have up to 15 minutes after receiving the page to use Meet Me Answer.

### *To make a Group Page:*

1. Lift the handset.
2. Press **Direct Page** or dial **\*37**.
3. Do one of the following:
  - To page your prime page group, press **#**.
  - To page a specific page group, dial the page group directory number.
4. Speak to the dialed party after the tone.

### *To respond to a Group Page by using Meet Me Answer:*

1. Lift handset.
2. Dial **\*88**.
3. Do one of the following:
  - To respond to a page from your prime page group, press **#**.
  - To respond to a page from a specific page group, dial the page group directory number.

## Trunk Flash

The Trunk Flash feature allows you to access Centrex features (if available) while you are talking on an outside call.

### *To flash a trunk while talking on an outside call:*

1. Press **TRANS/CONF**.
2. Dial **\*57** for a single flash or **\*56** for a double flash.
3. Wait for dial tone.
4. Dial the Centrex feature access code.

## Record a Call

This feature uses your voice mail system to record your telephone conversations.

**Note:** You may be required by law to inform the other party that you are recording the conversation. For specific instructions, consult your system administrator.

*To start recording while on a 2-party call:*

- Press the **Record Call** key. (See *Feature Keys* elsewhere in this guide for instructions on programming a **Record Call** key to your phone.)

**Note:** Your system may be programmed to automatically begin recording external calls when you or the other answers.

*To stop and save a recording:*

- Press the **Record Call** feature key.

Putting the call on hold saves the recording; taking the call off of hold starts a new recording. Depending on system programming, hanging up, or pressing **TRANS/CONF** or a **DSS/BLF** key, may also save the recording.

*To stop and erase a recording:*

- Press **CANCEL**.

*To listen to a recording:*

1. Lift the handset.
2. Access your voice mailbox.
3. Follow the prompts to retrieve the recording.

## Hot Desking

Hot Desking allows you to log into the telephone system from any phone designated as a Hot Desk phone. Simply log in at the phone using your assigned Hot Desk User Extension Number and the phone immediately assumes all your speed dials, features keys, call forwarding setup, and line appearances - even your language preference for the display. Any changes you make to the phone while you are logged in--for example, adding a speed dial--are saved to your personal profile. Logging in activates your profile on any phone that supports Hot Desking.

**Note:** All Hot Desking profiles have 13 programmable keys. If you log into a phone that has fewer keys, the extra ones are "hidden". Only the use of the extra keys is lost, not the features assigned to them.

*To log into a Hot Desking phone (the phone must be idle):*

1. Dial **222**.
2. Press **\*** to log in.
3. Enter your Hot Desk User Extension Number
4. Press **#** for OK or **<---** to correct your entry.
5. Enter your PIN number.
6. Press **#** for OK or **<---** to correct your entry.

*To log out of Hot Desking phone (the phone must be idle):*

1. Dial **333**.
2. Press **#** to log out.

**Note:** Your profile can only be active on one phone at a time. If you log in from another phone without logging out from the first one, the system will automatically deactivate your profile on the first phone.

### Hot Desk Remote Logout

A user who has forgotten to log out of a Hot Desking phone can be logged out using any phone that supports Hot Desk Remote Logout.

*To remotely log out a Hot Desking phone:*

1. Dial **111**.
2. Dial the Hot Desk User Extension Number that you want to log out.

## Tag Call

Tag Call allows you to signal that you are the victim of a threatening or malicious call. Using the tag, your system administrator or telephone company can identify the source of the call and provide this information to appropriate personnel or authorities.

**CAUTION: Tagging a non-malicious call may result in fines or other penalties.**

*To tag a malicious call:*

- Press the **Tag Call** feature key while the call is in progress.  
See "Feature Keys" elsewhere in this guide for information on programming a Tag Call feature key to your phone.  
-OR-
- Press **TRANS/CONF**.
- Dial **\*55**.

If the call was successfully tagged "Thank You" is shown on the display; otherwise, "Not Allowed" is displayed.

**Note:** Tag Call can be used on active two-party calls only. Calls on hold and conference calls cannot be tagged.

## Call History

Call History keeps track of the names (if available) and telephone numbers of missed calls, answered incoming external calls, and outgoing external calls. Once enabled on your phone by your system administrator, it functions automatically.

*To display the call history, and view call detail:*

1. Press the **Call History** feature key. The total number of missed calls is displayed in brackets ( ), the number of new missed calls is indicated with a \*.
2. To browse through the list of missed calls, press the \* key (Yes), followed by the **UP** and **DOWN** keys to scroll through the list. To view answered or outgoing calls, press the # key (No) once for answered, twice for Outgoing. Use the **UP** and **DOWN** keys to scroll through the list of answered or outgoing calls.
3. To view the number of the call, press the # key (Options). When the options screen is displayed, press the \* key (Details) to display the number. From the number display, press the # key (Next) to display the call time and date.

*To return a call:*

1. Display the call you want to return.
2. Do one of the following:
  - If the call is internal, and the caller name is known, press the \* key (Call). For unknown numbers, the \* key is not displayed.
  - If the call is external, and you normally need to precede external calls with a digit such as 9, it's likely that your system administrator has programmed your system to insert the 9 for you. In this case, pressing the \* key (Call) initiates the call immediately. Sometimes the system will be unable to complete the dialing automatically. When this happens, you can edit the dialed digits manually by pressing the # (Clear) key. Use the # key to delete the left-most digit, and then type the digits to insert them. When you have the dial string edited to suit your needs, press the \* key (Call) to dial the number.

*To delete all missed, answered, or outgoing call logs:*

1. After selecting the type of logs you wish to delete, press the # key (Delete All).
2. Confirm that you do want to delete all items by pressing the \* key (Yes).

*To delete a particular call from the call log:*

1. With the call log that you want to delete displayed, press the # key (Options). The Options menu is displayed.
2. Press the # key (Delete) to delete the log.

## FEATURE ACCESS CODES

Save Last Number	**79
Repeat Last Number Saved	*6*
Personal Speedcall - Invoke	58
Personal Speed Call - Upper Range Index Number	09
Personal Speedcall - Store	67
Call Hold - Remote Retrieve	**1
Conference Call Split	*41
Cancel Call Forwarding Follow Me - Remote	**77
Cancel Call Forwarding Follow Me	#8
Call Forwarding - End Chaining	64
Cancel Call Forwarding - End Chaining	**73
Call Forwarding - Override	*1*
Callback - Cancel Individual	#1*
Callback - Cancel	#1
Account Code	**3
Call Park - Remote Retrieve	*23
Call Pickup - Directed	**6
Do Not Disturb - Remote	**5
Do Not Disturb - Cancel Remote	##5
Direct Page	*37
Meet Me Answer	*88
Trunk Single Flash	*57
Trunk Double Flash	*56
Hot Desking Login	222
Hot Desking Logout	333
Remote Hot Desking Logout	111
Tag Call	*55



**MH Communications (UK) Ltd.**

Springsteen House, 497 Warrington Road

Rainhill, Merseyside, L35 0LR

Telephone: 0871 871 8712

Fax: 0871 871 8715

Email: [info@mhcomms.co.uk](mailto:info@mhcomms.co.uk)

[www.mhcomms.co.uk](http://www.mhcomms.co.uk)



™, © Trademark of Mitel Networks Corporation.  
© Copyright 2005, Mitel Networks Corporation.  
All rights reserved.